

Libluh Tanay

PANIMULANG AKLAT

Pre-Primer

MANILA LIBRARY
MANILA LIBRARY

TAGABILI

P.-291

ACKNOWLEDGMENTS

The following pre-primer is a modified translation from Panimulang Aklat, a Pre-Primer, by Ursula E. Calma, edited by Ines Cruz, and published and distributed by Philippine Book Company, (1948). The Summer Institute of Linguistics wishes to thank Mr. M. J. Enriquez for his kind permission to translate the material into Tagabili. His aim in granting such permission coincides with that of the Institute--that Tagabilis may learn to read their own dialect as a bridge to learning the Filipino National Language and thus become more than ever a part of the national stream of life.

In this translation, illustrations as well as content have been modified to conform to Tagabili culture.

Executive Secretary Rufino Alejandro of the Institute of National Language supplied the Tagalog in those sections of the primer which differ from the original because of a different material culture.

The paper used in this book was a gift of the United States Information Service.

INTRODUCTION

Tagabili is the dialect spoken by an estimated 20,000 persons living in southern Cotabato--in the southern part of Alah Valley, the Lake Sebu area, and southwest to the coast.

The phonemes of Tagabili include 14 consonants and six vowels: b,k,d,f,g,h,l,m,n,ng,s,t,w,y, and i,e,ʌ,a,u,o.

The following letters are pronounced very much like their Tagalog equivalents: a,b,k,d,g,i,l,m,n,ng,t,w,y. Word-final h is silent when followed by another consonant: dumuh, 'companion'; dumu(h) takuy, 'our companion'; but dumuhuh, 'my companion'. When s precedes i, the sound is similar to that in the English words shoe and shield. Pronunciation of f is as in English fish. When occurring between vowels, d is often pronounced as the Spanish r in para, 'for': tadok (trok), 'finger'. The final r of borrowed words becomes l: doktol, 'doctor'; tadaktol (traktol), 'tractor'. Clusters of two or more consonants are found most frequently in rapid speech; balat, 'heavy', is often pronounced blat. A few consonant clusters do occur as part of the regular word structure: hankan, 'feed'.

When preceding y, e is pronounced as in Spanish de, 'give'; elsewhere it is pronounced as in the English word let. The vowel ʌ is pronounced somewhat like the vowel in English cup or the first vowel in above, varying in some speakers to a sound approaching that of the pepet vowel. The pronunciation of u fluctuates between the Spanish u and o. The o varies between the vowel in English cough and a sound halfway between that and a Spanish o.

Kade Lah

Ang Mag-anak

The Family

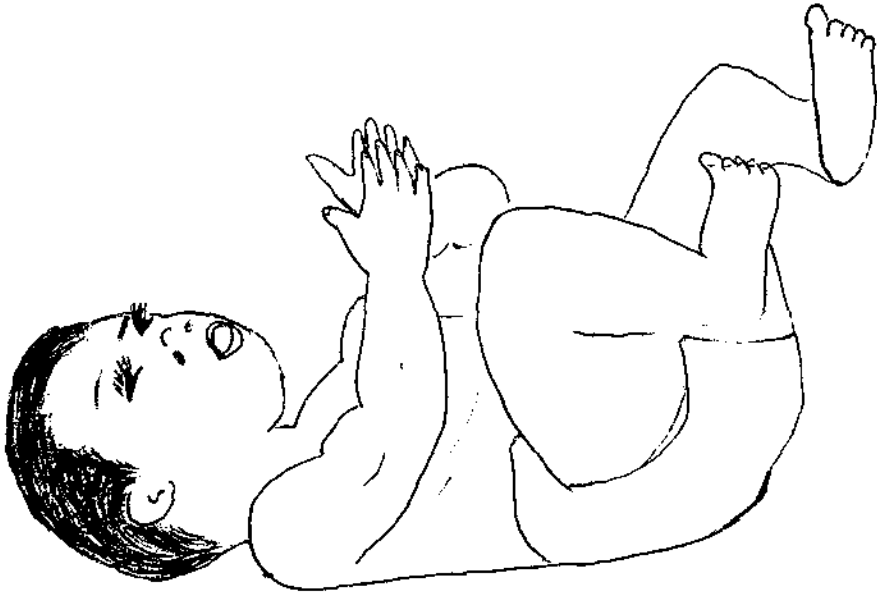

nga
Nih nga.

sanggól
Itó ay sanggól.

baby
This is a baby.



Kuya
nga logih
Nih nga logih.
Nih Kuya.

Kuya
batang lalaki
Itó ay batang lalaki.
Itó ay si Kuya.

Kuya
boy
This is a boy.
This is Kuya.

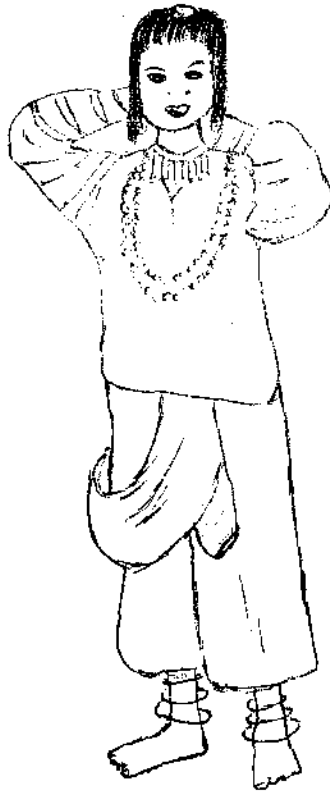

Ate
nga libun
Nih nga libun.
Nih Ate.

Ate
batang babae
Itó ay batang babae.
Itó ay si Ate.

Ate
girl
This is a girl.
This is Ate.

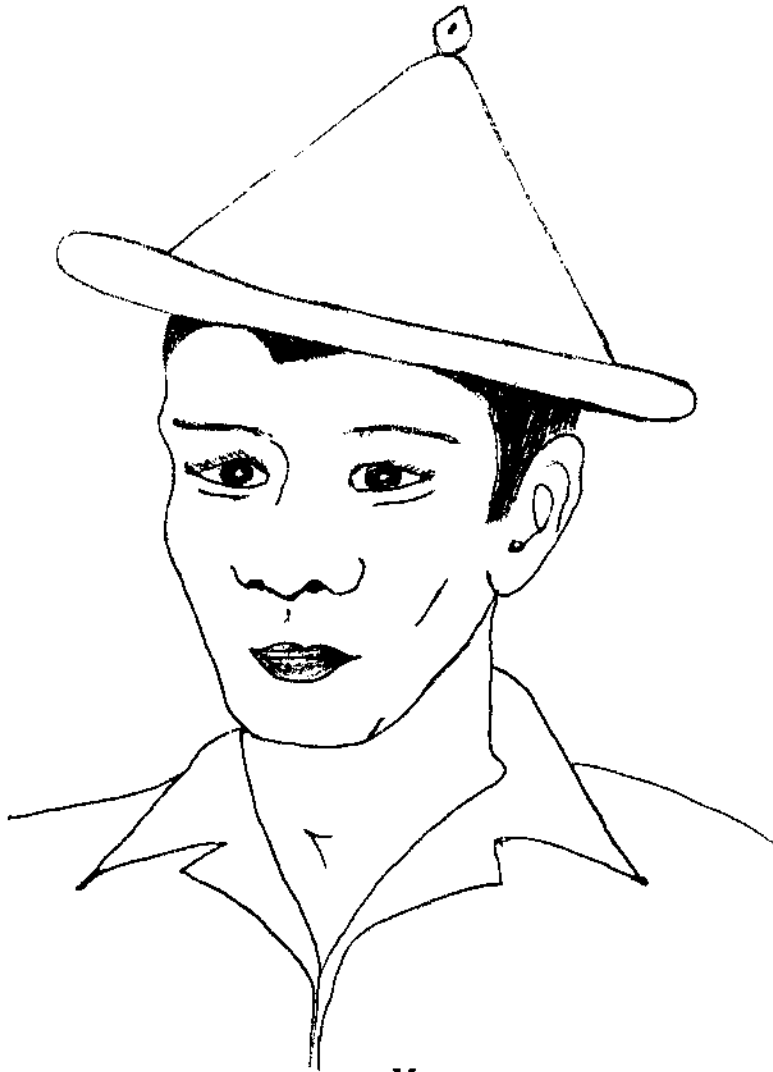

Ma
Ma tay hayuh tauh.

Tatay
Ang Tatay ay mabait na tao.

Father
Father is a good man.

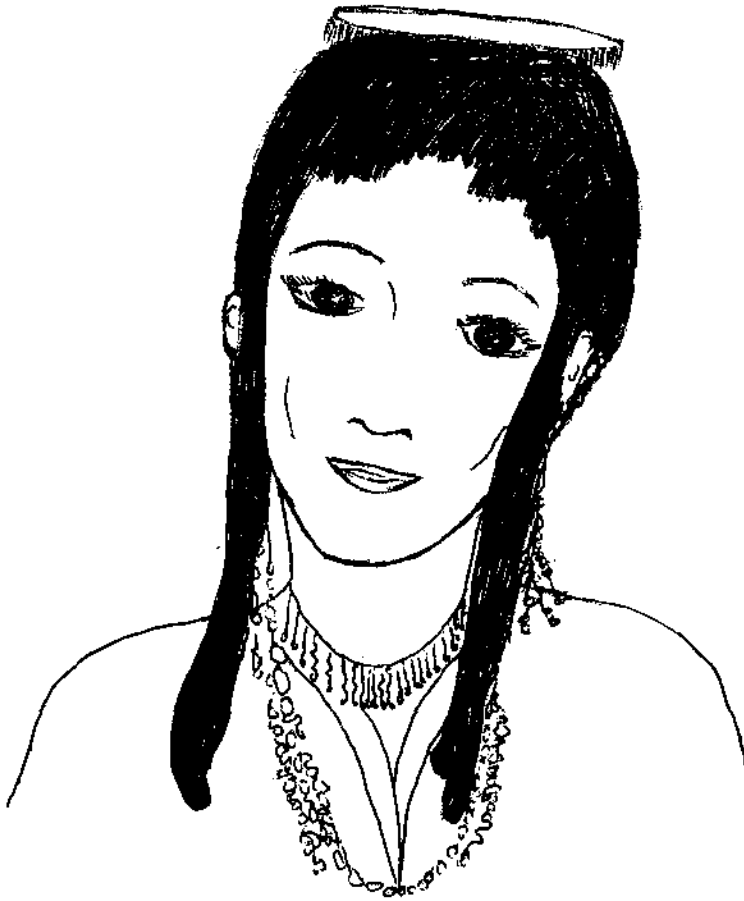

Ye
Tay hayuh Ye.

Nanay
Ang Nanay ay mabait.

Mother
Mother is good.



Ma D1
tuwalih
Ma D1 tuwalih Ye luwuh Lah Ma.

Tiyó
kapatíd
Ang Tiyó ay kapatíd na lalaki
ni Nanay at ni Tatay.

Uncle
brother
Uncle is a brother of
Mother and Father.

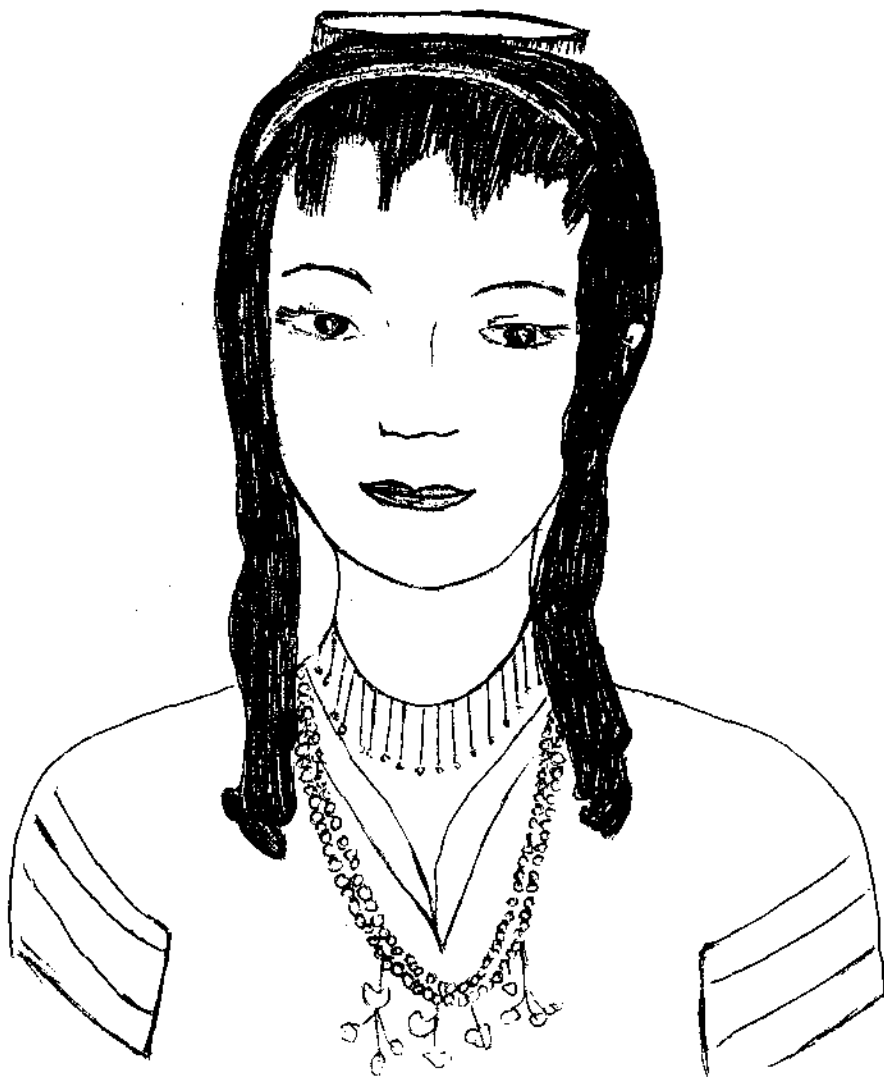

Ye Di
Ye Di tuwalih Ye luwuh lah Ma.

Tiyá
Ang Tiyá ay kapatíd na babae
ni Nanay at ni Tatay.

Aunt
Aunt is a sister of Mother
and Father.



Teme
Teme ma Ye luwuh lah Ma.

Lolo
Siyá ay tatay ni Nanay
at ni Tatay.

Grandfather
He is the father of
Mother and Father.



Beh
tuhah
Beh tuhah libun.

Lola
matandâ
Ang Lola ay matandang babae.

Grandmother
old
Grandmother is an old woman.

KAM SANAAM DUH NU BA GUNU

Mga Kagamitán sa Bahay

Things in the House

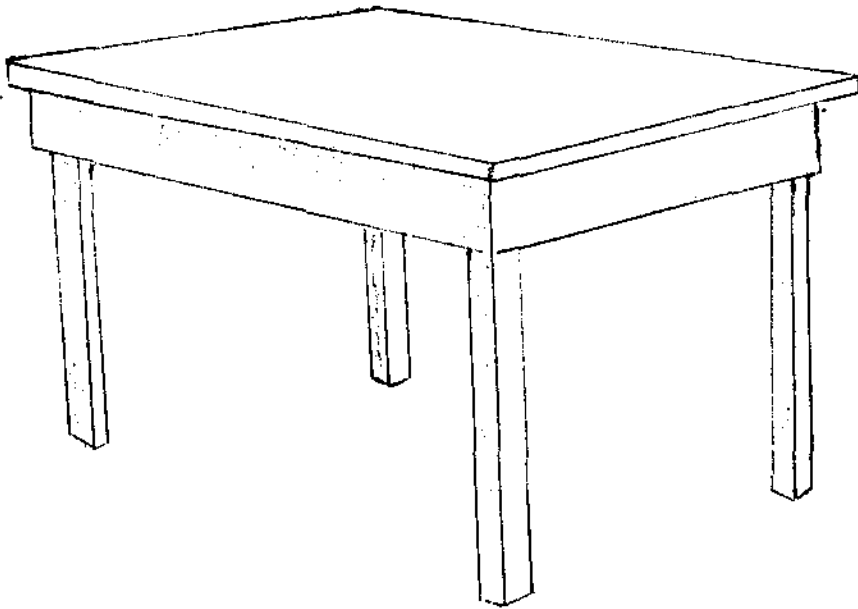

lamisah
Nih lamisah.

mesa
Itó ay mesa.

table
This is a table.

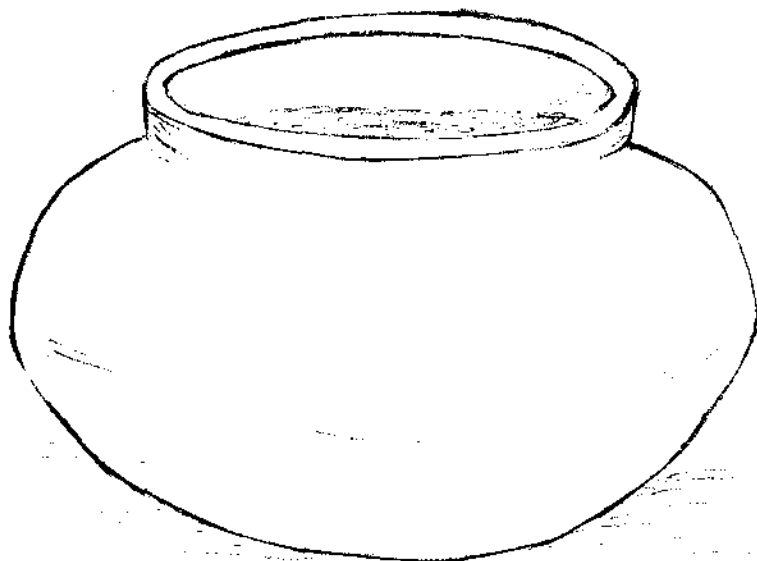

kulang
tamogoh
Nih kulang.
Gal gunu tamogoh.

palayók
paglulutò
Itó ay palayók.
Itó ay gamit sa paglulutò.

pot
cooking
This is a pot.
This is used for cooking.

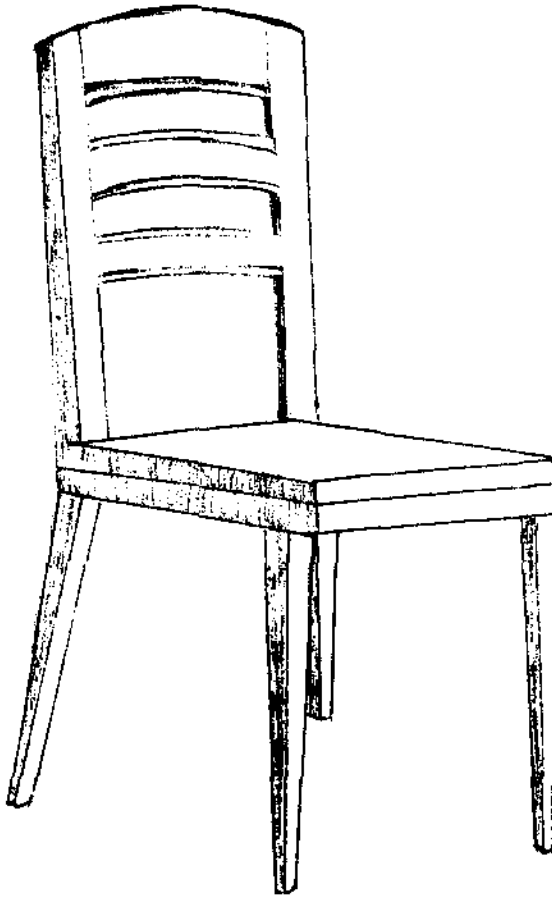

bangku
Yoh bangku.
Gunu gal miyan bangku.

silya
Ang silya.
Ang silya ay úpuan.

chair
The chair.
The chair is a seat.

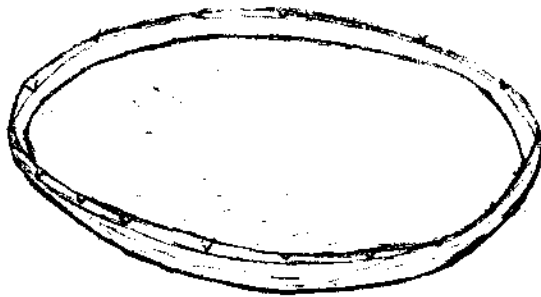

biguh
Nih biguh.
Biguh mo gal taaf halay.

bilaong pantahíp
Itó ay bilaong pantahíp.

Itó ay gamit sa pagtatahíp
ng bigás.

winnowing basket
This is a winnowing
basket.

This is used to winnow
rice.

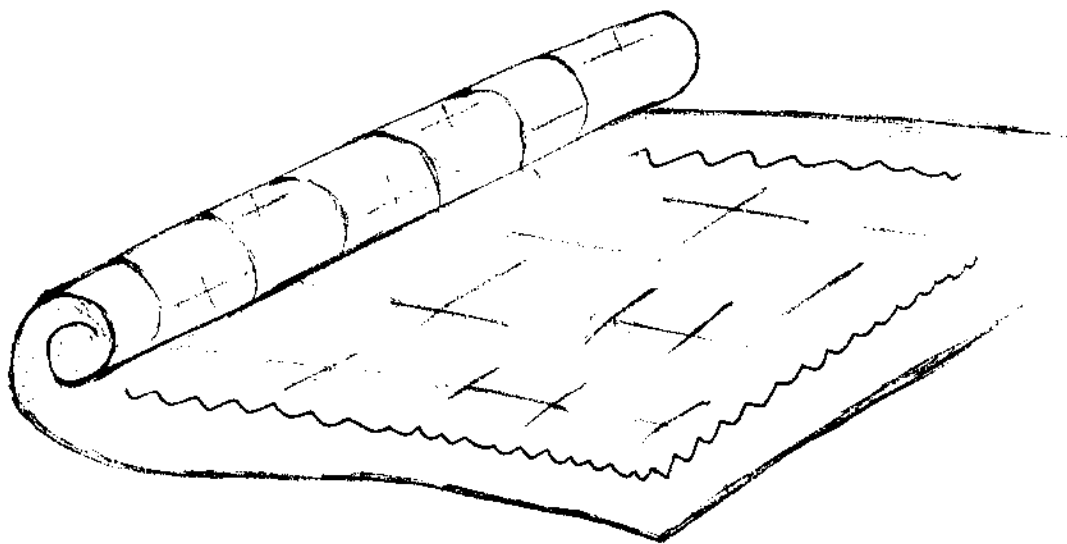

igam
Nih igam.
Igam gal gunu tungò.

banig
Itó ay banig.
Ang banig ay gamit
sa pagtulog.

mat
This is a mat.
This mat is used
when going to sleep.

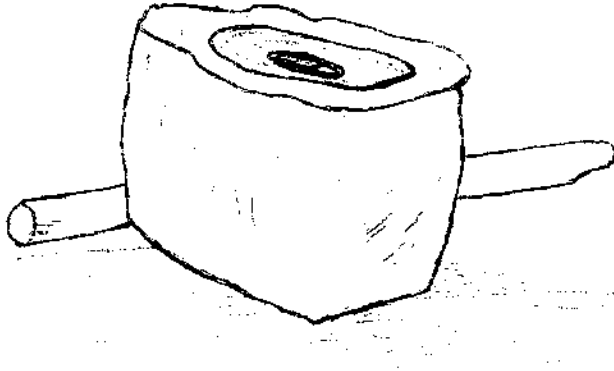

sung

Nih sung.

Sung gunu gal madak halay.

lusóng

Itó ay lusóng.

Ang lusóng ay gamit
sa pagbabayó ng bigás.

mortar

This is a mortar.

The mortar is used
in pounding rice.

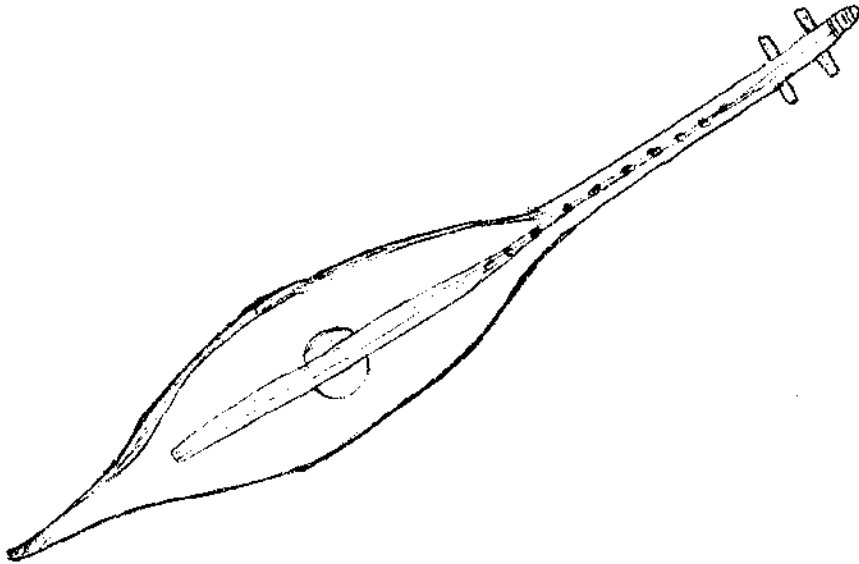

hagalung
kanbit
Nih hagalong.
Hagalung mo gal kanbit.

gitara
kalabít
Itó ay gitara.
Ang gitara ay kinákalabít.

guitar
pluck
This is a guitar.
The guitar is plucked.

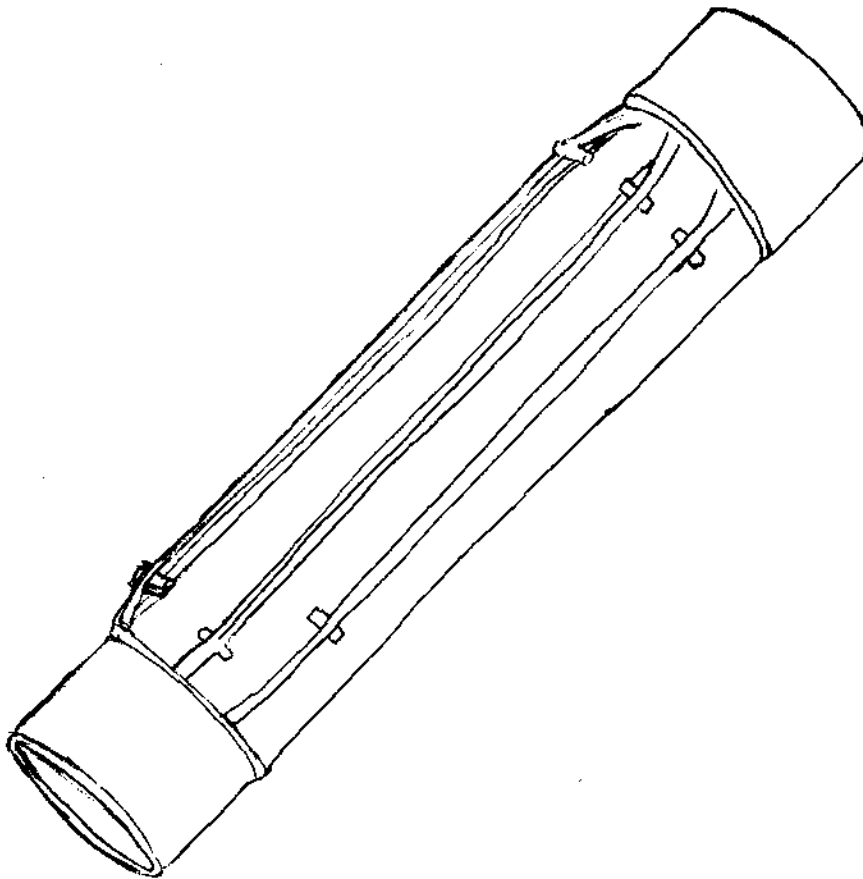

saludoy

landay

Saludoy landay unihan.

(No sound.)

gitarang kawayan
magandá

Itó ay gitarang kawayan.

Ang gitarang kawayan ay may
magandang tunóg.

bamboo guitar
pretty

This is a bamboo guitar.

The bamboo guitar has
a pretty sound.

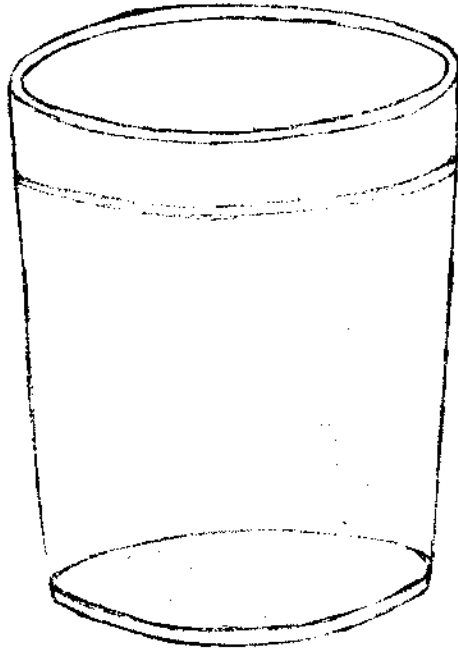

basu
Nih basu.
Basu gal gunu minum.

baso
Itó ay baso.
Ang baso ay gamit
sa pag-inóm.

glass
This is a glass.
A glass is used
for drinking.

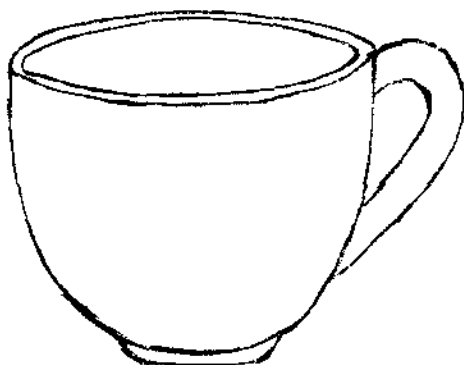

tagayan
Nih tagayan.

tasa
Itó ay tasa.

cup
This is a cup.

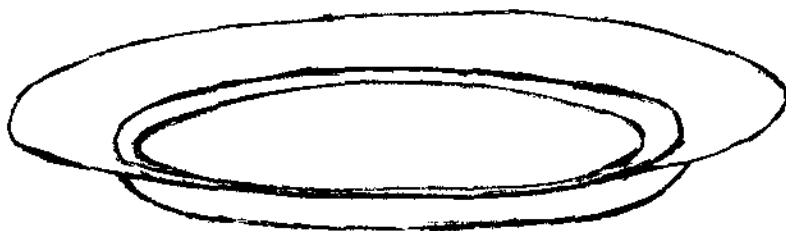

huyow
Nih huyow.

pinggán
Itó ay pinggán.

plate
This is a plate.



salidut
Nih salidut.

kutsara
Itó ay kutsara.

spoon
This is a spoon.

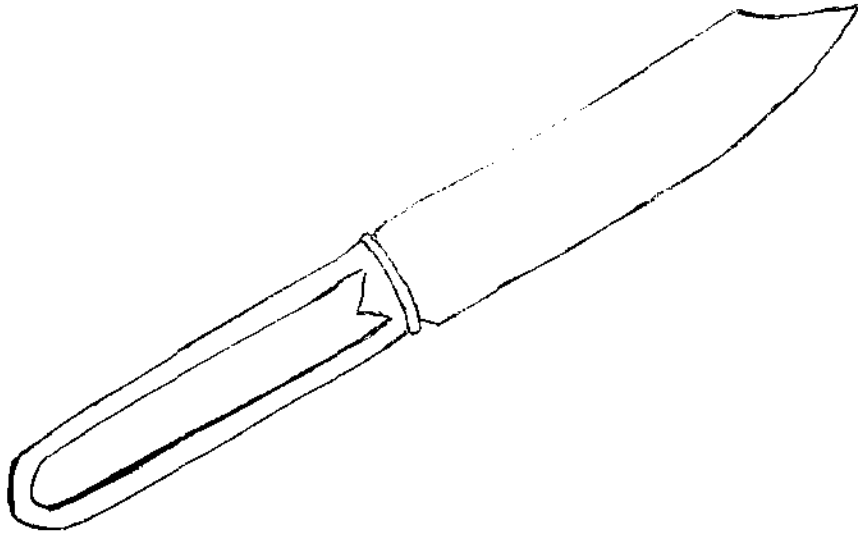

suk

Nih suk.

Suk gal kalab sanaam duh.

kutsilyo

Itó ay kutsilyo.

Ang kutsilyo ay panghiwà
ng maraming bagay.

knife

This is a knife.

A knife cuts many
things.

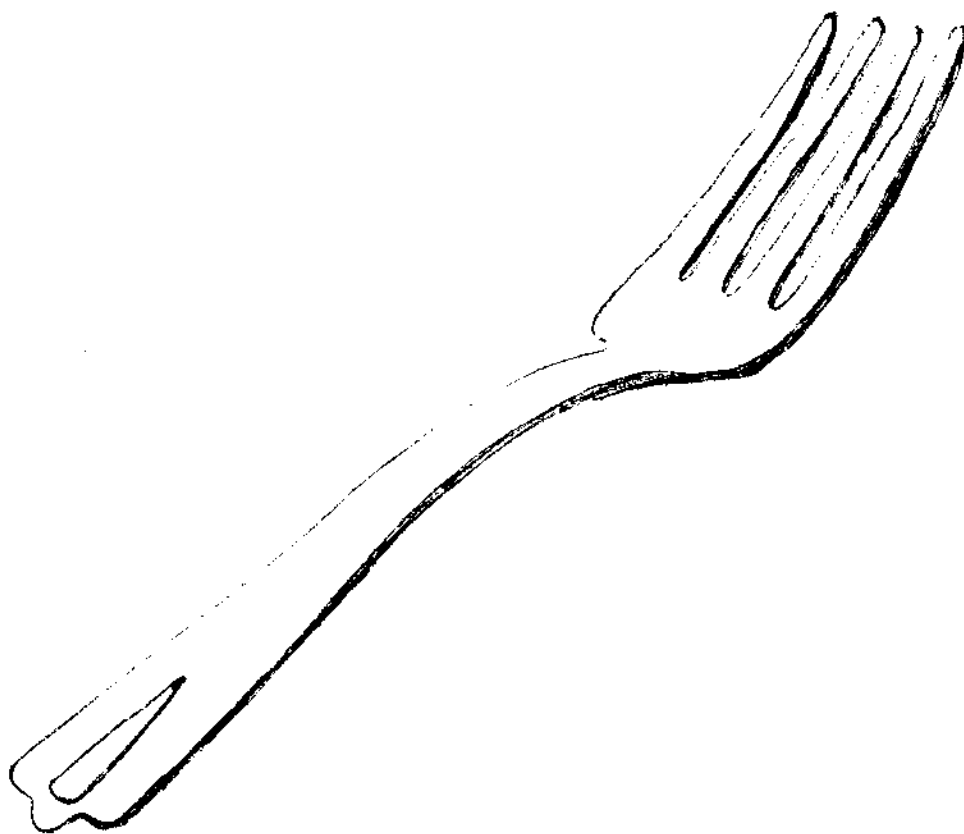

tabak
Nih tabak.
Tabak gal tabak utun.

tinidór
Itó ay tinidór.
Ang tinidór ay gamit
sa pagkain.

fork
This is a fork.
The fork is used
in eating.

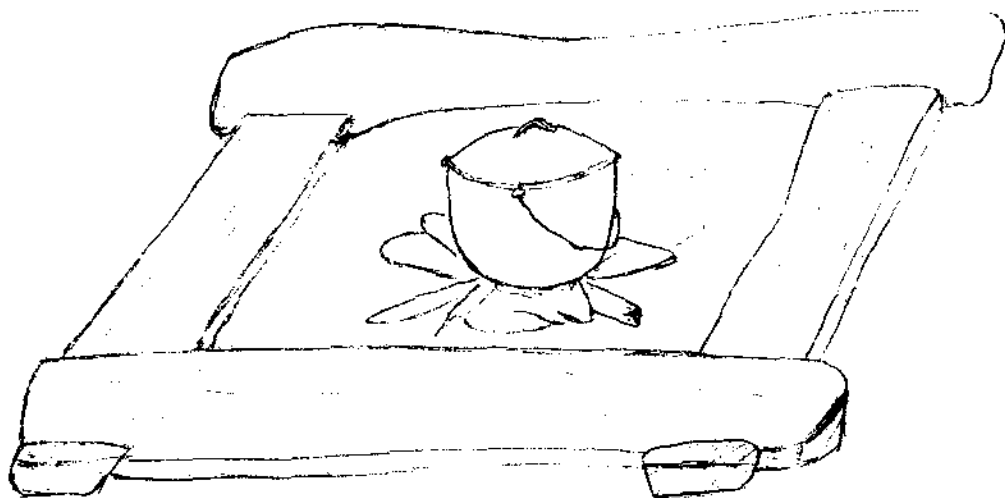

kahu
Nih kahu.
Kahu gal gunu tamogoh.

kalán
Itó ay kalán.
Ang kalán ay gamit
sa paglulutò.

stove
This is a stove.
This stove is used
for cooking.

KAM DE KAN

Maraming Pagkain

Many Foods

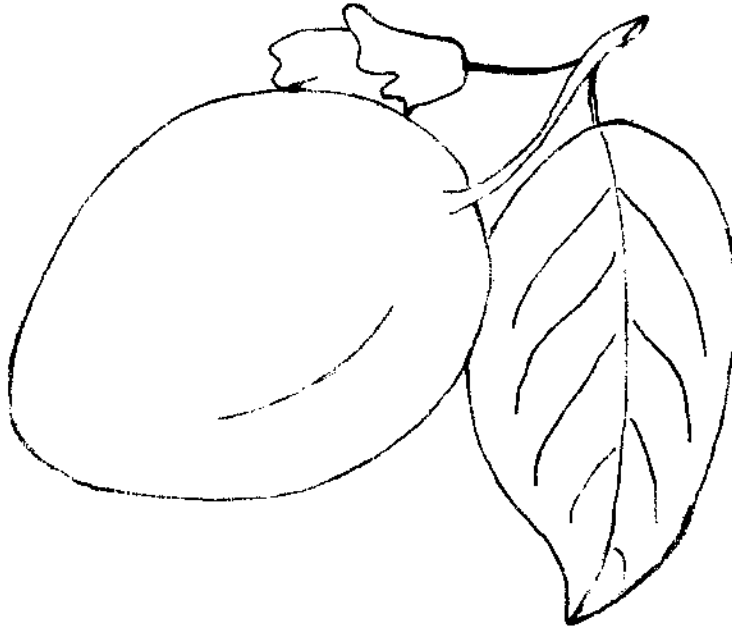

bayabas

lalnaw

magal

Lalnaw bayabas nih.

Bayabas lalnaw tay magal.

bayabas

luntian

matigás

Ang bayabas na itó ay luntí.

Ang bayabas na luntí ay matigás.

guava

green

hard

This guava is green.

A green guava is hard.

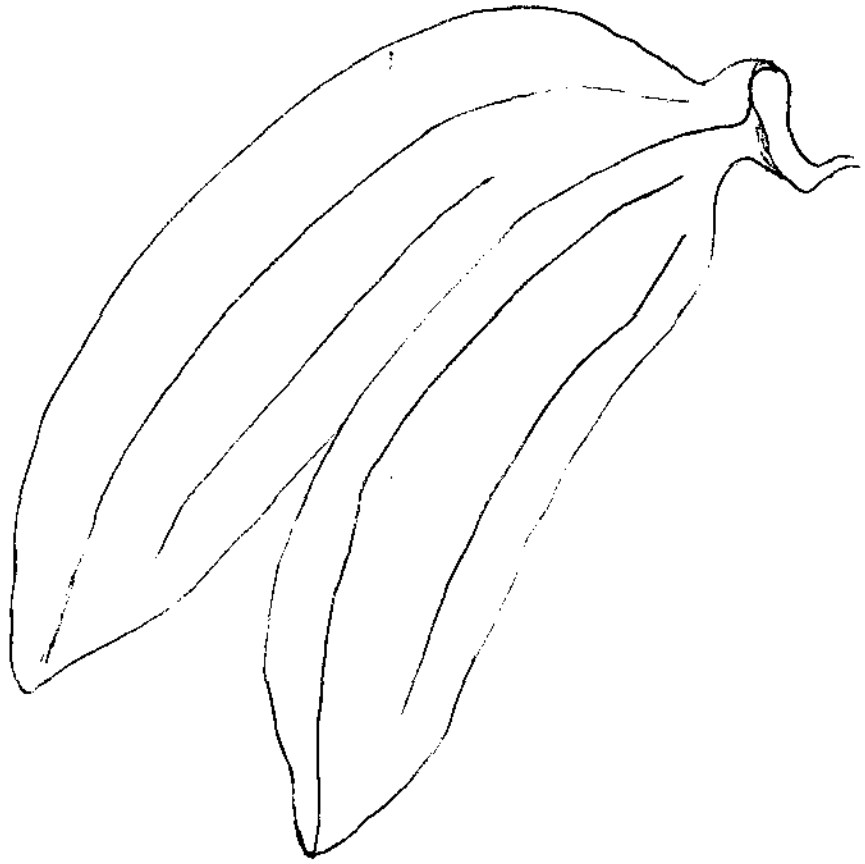

soging
togoh
Luwuh soging nih
Togoh lah kam soging nih.

saging
hinóg
Itó ay dalawáng saging.
Ang mga saging na itó ay hinóg.

banana
ripe
These are two bananas.
These bananas are ripe.

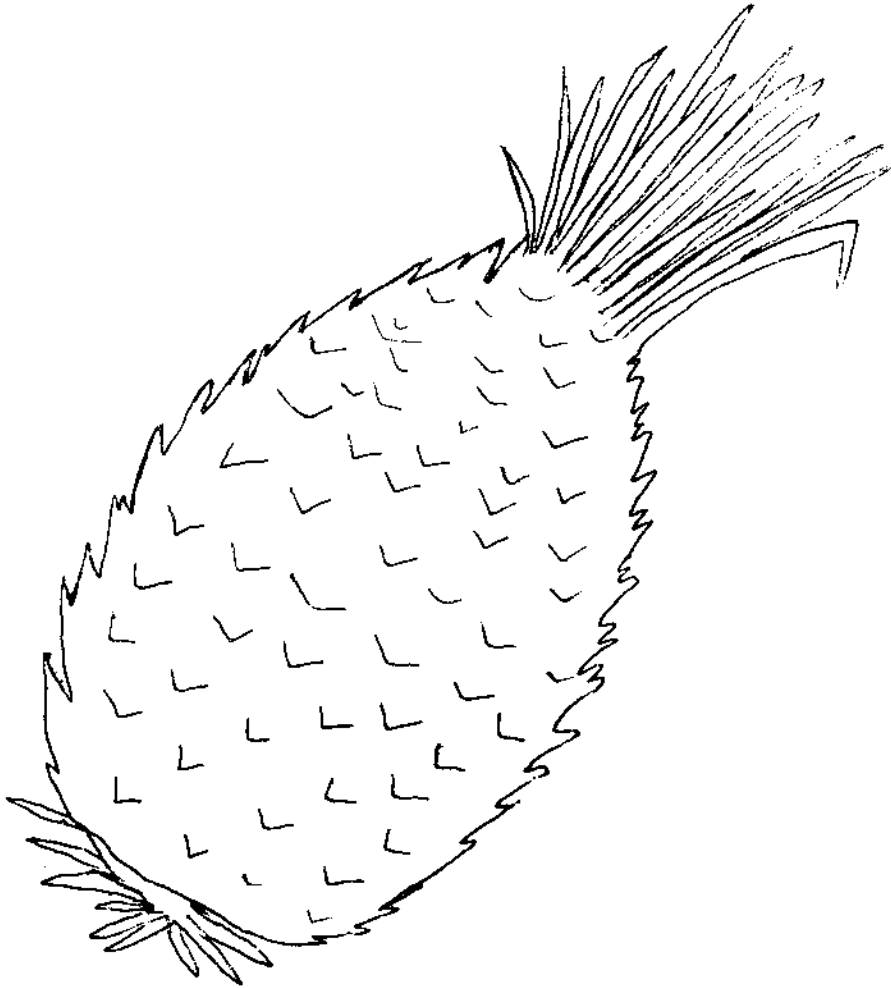

lanas
matah
Nih lanas.
Lanas de matahan.

pinyá
matá
Itó ay pinyá.
Ang pinyá ay maraming matá.

pineapple
eye
This is a pineapple.
A pineapple has many eyes.

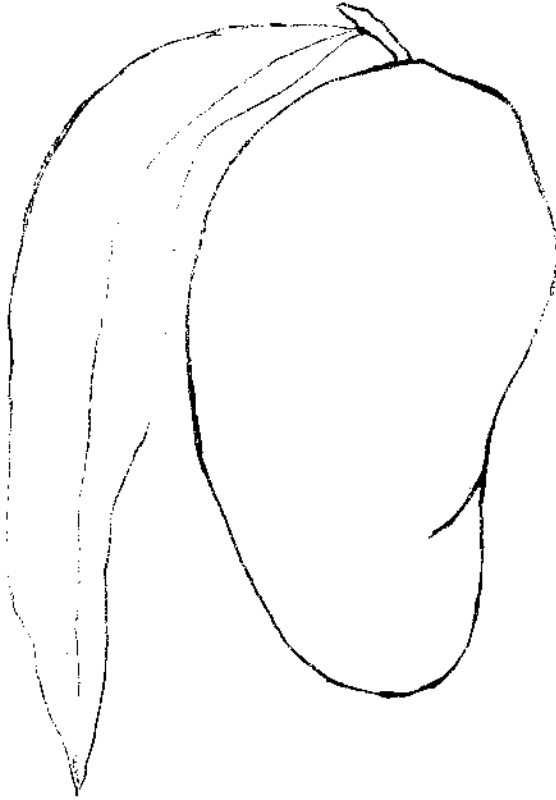

mangga

melel

Nih mangga.

Melel mangga nih.

Melel mangga togoh.

manggá

diláw

Itó ay manggá.

Ang manggáng itó ay diláw.

Ang diláw na manggá ay hinóg.

mango

yellow

This is a mango.

This mango is yellow.

A yellow mango is ripe.

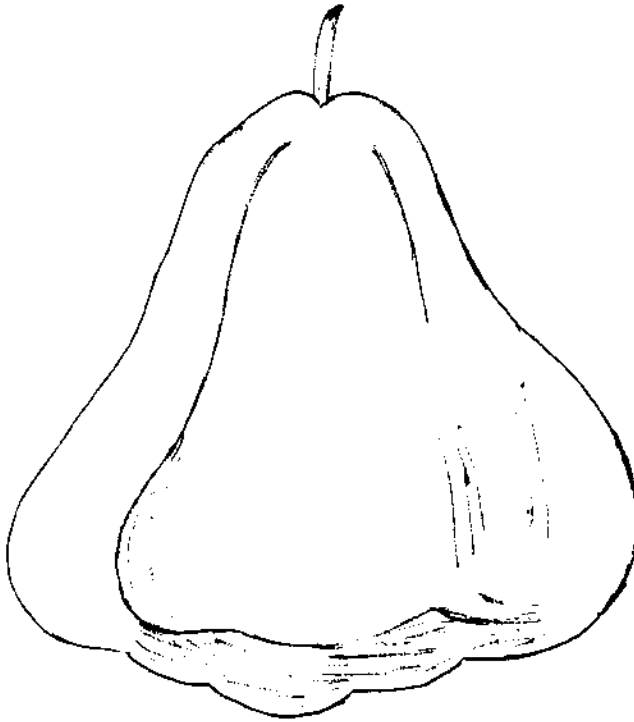

tuwol
Nih tuwol.
Hulo kulitan tuwol.

makopa
Itó ay makopa.
Ang balát ng makopa
ay pulá.

macopa
This is a macopa.
The skin of a macopa
is red.

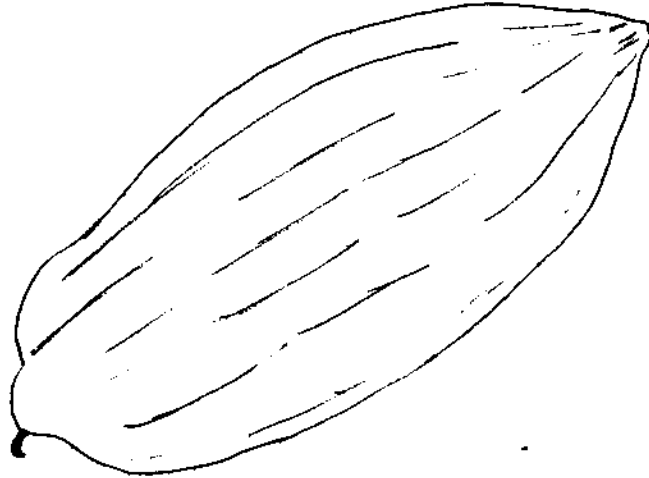

tafaya
Nih tafaya.
Tafaya togoh mih.

papaya
Itó ay papaya.
Ang hinóg no papaya
ay matamis.

papaya
This is a papaya.
A ripe papaya
is sweet.



salabi
Nih salabi.

petsay
Itô ay petsay.

pechay
This is pechay.

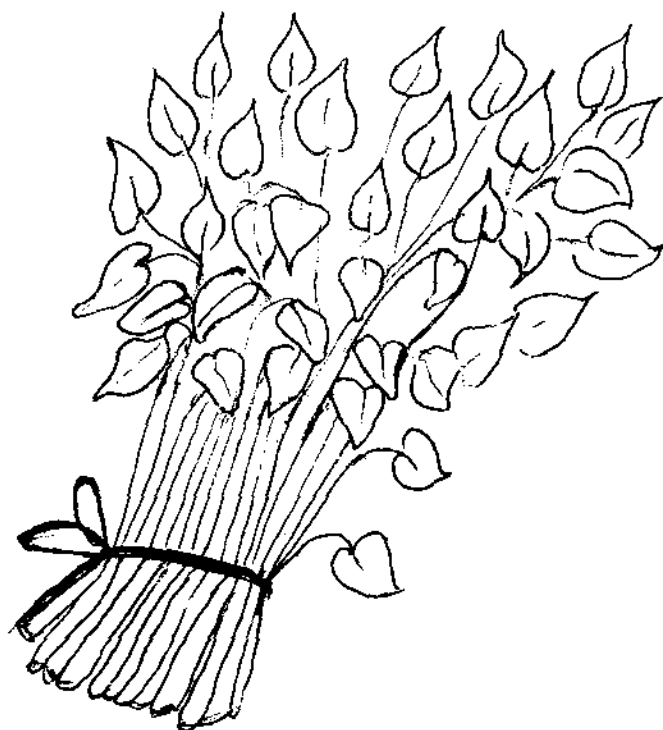

tangkung
doun
Nih tangkung.
Doun tangkung.

kangkóng
talbós
Itó ay kangkóng.
Talbós ng kangkóng.

kangkong
tops
This is kangkong.
Kangkong tops.



kamati

hulo

Nih kamati.

Togoh kamati mih.

Kamati togo hulo.

kamatis

mapulá

Itó ay kamatis.

Ang kamatis na itó ay hinóg.

Ang kamatis na hinóg ay mapulá.

tomato

red

This is a tomato.

This tomato is ripe.

A ripe tomato is red.

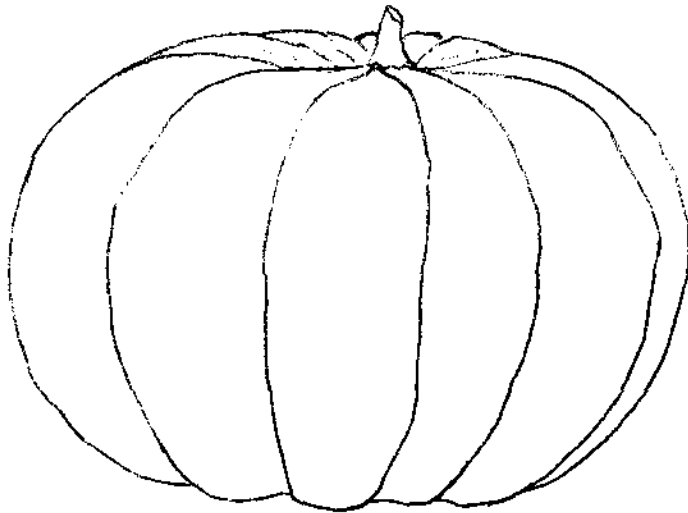

basuk
bong
Nih basuk.
Bong basuk nih.

kalabasa
malaki
Itó ay kalabasa.
Ang kalabasang itó ay malaki.

squash
big
This is a squash.
This squash is big.

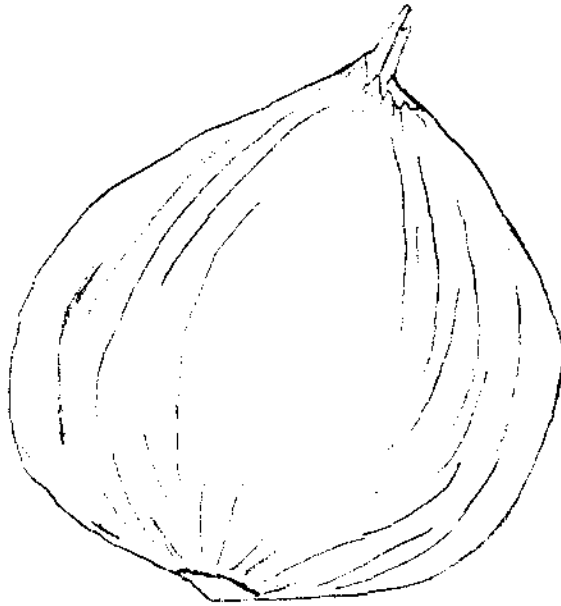

kasunah
Nih kasunah.

sibuyas
Itó ay sibuyas.

onion
This is an onion.

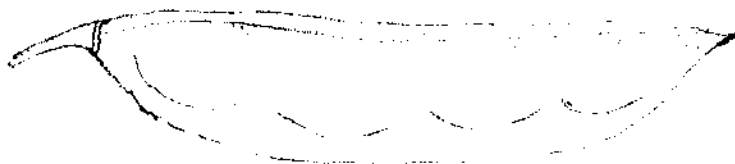

bulih
Nih bulih.

patani
Itó ay patani.

bean
This is a bean.

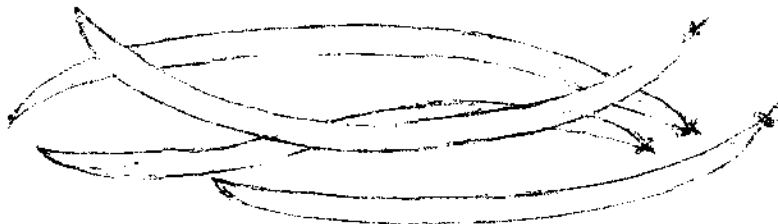

ɔlangul
Nih ɔlangul.

sitaw
Itó ay sitaw.

string beans
These are string beans.



lafa ubih.
Nih lafa ubih.

talbós ng kamote
Itó ay talbós ng kamote.

camote tops
These are camote tops.

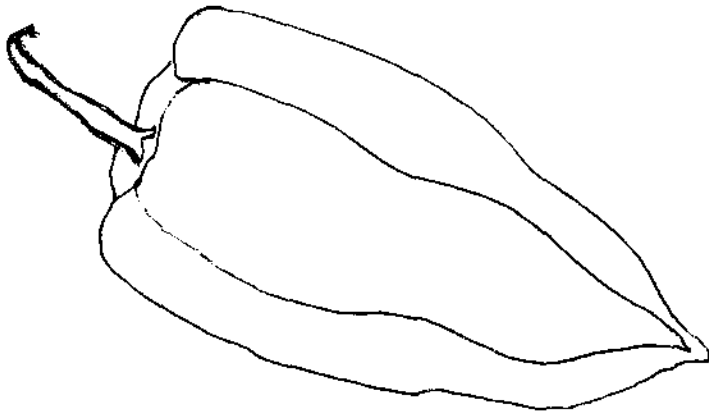

malah
das
Nih malah.
DAS malah nih.

sili
maangháng
Itó ay sili.
Ang sili ay maangháng.

pepper
hot
This is pepper.
Pepper is hot.

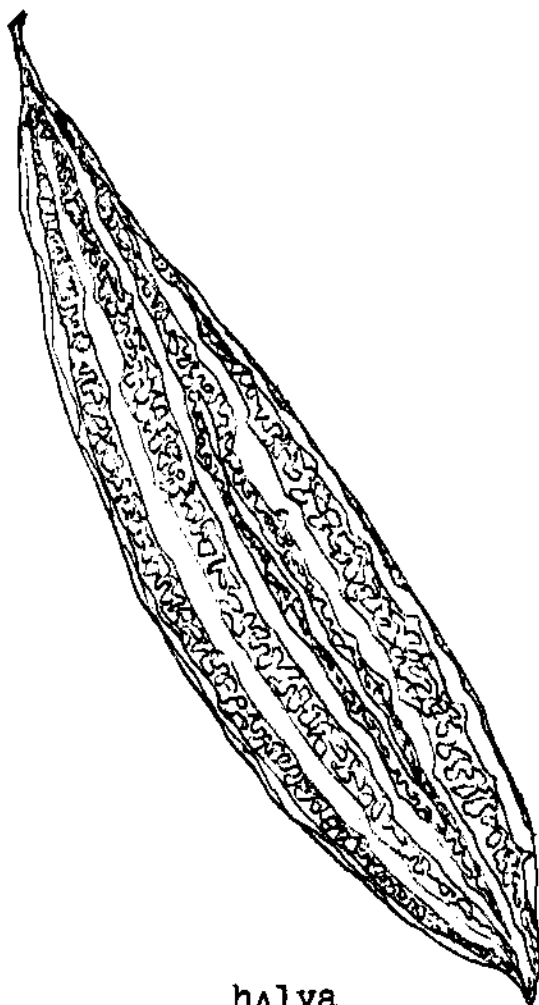

halya
heet
Nih halya.
Heet halya.

ampalayá
mapait
Itó ay ampalayá.
Ang ampalayá ay mapait.

amargoso
bitter
This is an amargoso.
Amargoso is bitter.

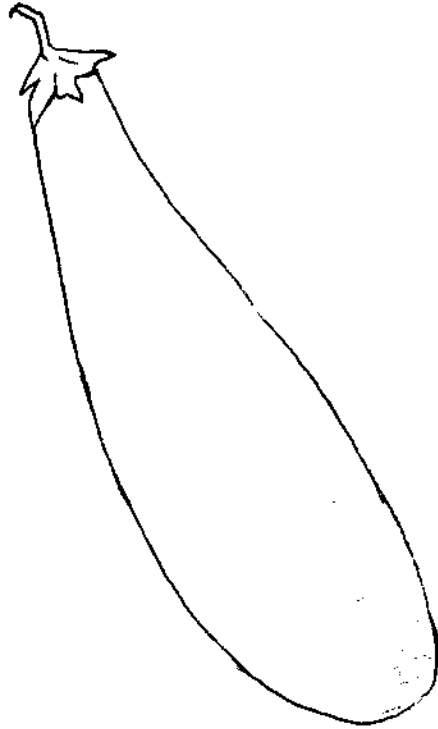

sagotong

hulo

Nih sagotong.

Hulo kulitan sagotong.

talóng

lila

Itó ay talóng.

Ang balát ng talóng

ay lila.

eggplant

violet

This is an eggplant.

The skin of the eggplant

is violet.



ubih

Nih ubih.

Tay hayuh tanete ubih.

kanote

Itó ay kanote.

Mabuti ang mag-ihaw ng kanote.

camote

This is a camote.

It is good to roast camote.

Kam Ugaf

Mga Kaibigang Hayop

Pets



ohuh
nga ohuh
Ohuh nah nga ohuh.

aso
tutà
Ang aso at ang tutà.

dog
puppy
The dog and the puppy.

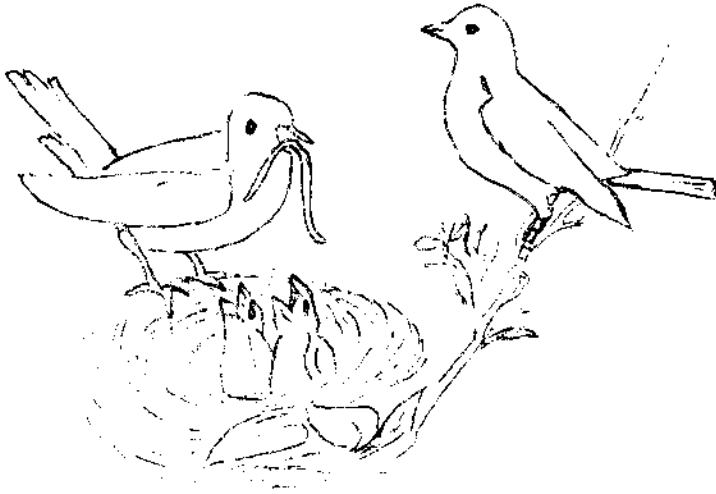

onuk koyuh
nga onuk koyuh
Kam onuk koyuh.
Kam onuk koyuh wan luwuh ngaan.

ibon
inakáy
Ang mga ibon.
Ang mga ibon ay may
dalawang inakáy.

bird
birdie
The birds.
The birds have
two birdies.

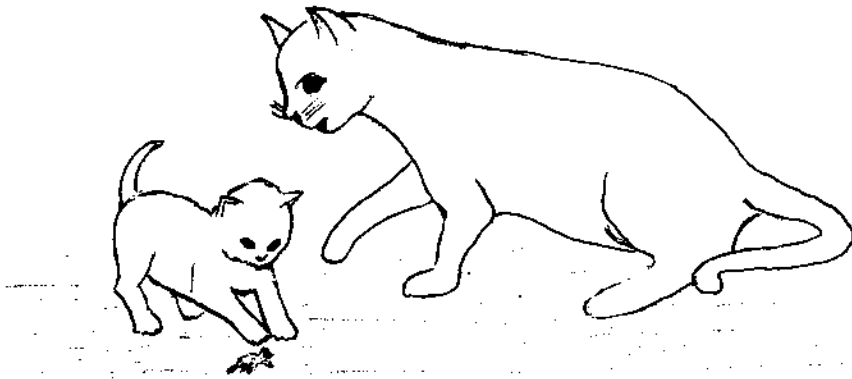

kuku
nga kuku
Kuku nah ngaan.

pusa
kuting
Ang pusa at ang kuting.

cat
kitten
The cat and the kitten.



uhuh
nga uhuh
Uhuh nah nga uhuh.

usá
guyà
Àng usá at ang guyà

deer
fawn
The deer and the fawn

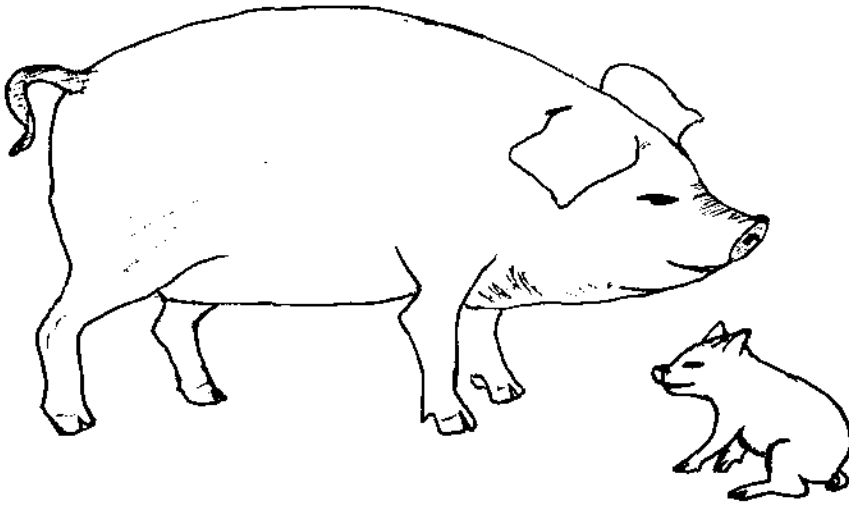

sado
nga sado
Sado nah nga sado.

baboy
bifik
Ang baboy at ang bifk.

pig
piglet
The pig and the piglet.

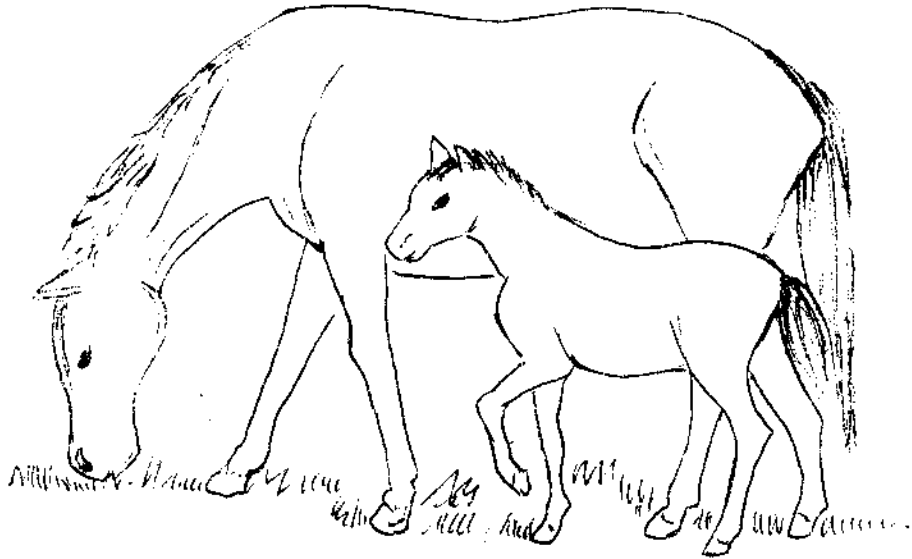

^u
kōda
nga koda
Kōda nāh nga kōda.

kabayo
bisiro
Ang kabayo at ang bisiro

horse
colt
The horse and the colt

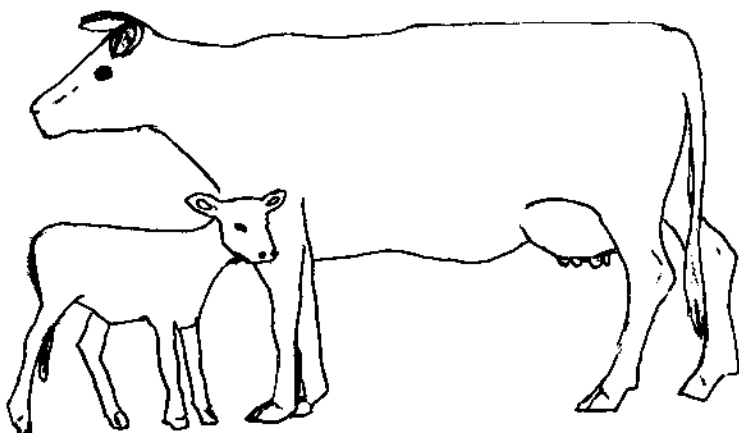

safi
nga safi
Safi nah nga safi

baka
guyà
Ang baka at ang guyà

cow
calf
The cow and the calf.

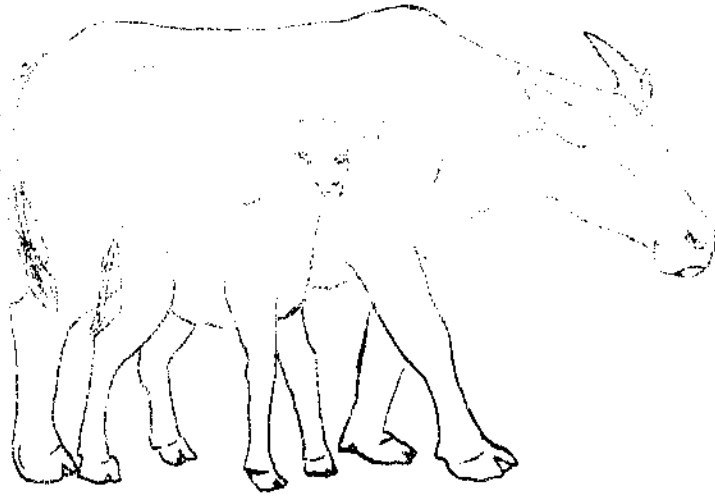

kALAMBAW
nga kALAMBAW
KALAMBAW nah nga kALAMBAW.

kalabáw
bulô
Ang kalabáw at ang bulô

carabao
calf
The carabao and the calf

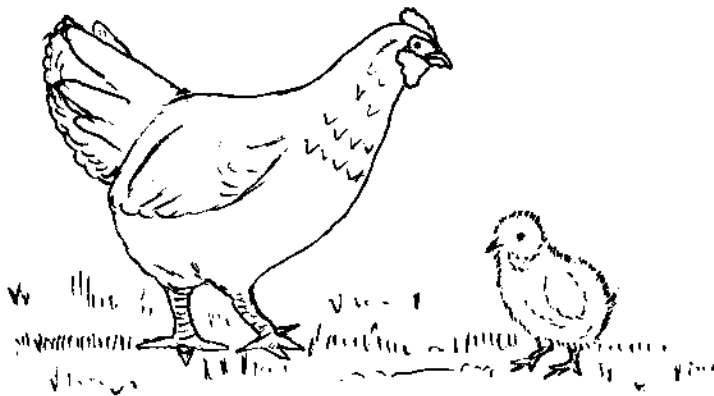

onuk
nga onuk
Onuk wan ngaan.

inahing manók
sisiw
Ang inahing manók ay may sisiw.

hen
chick
The hen has a chick.

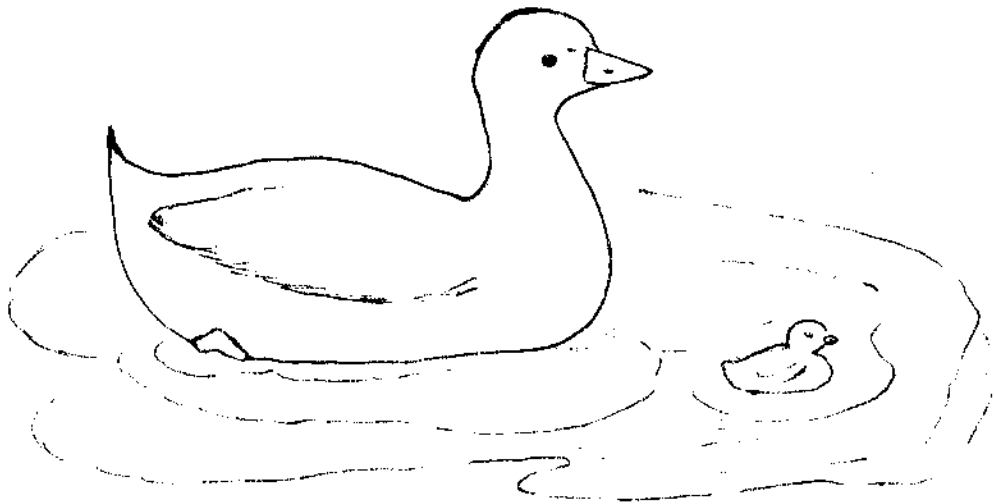

inti
Inti wan ngaan.
Inti nan ngaan sulif ba el.

pato
Ang pato ay may inakáy.
Ang pato at ang inakáy
ay naglalarô sa tubig.

duck
The duck has a duckling.
The duck and the duckling
are playing in the water.

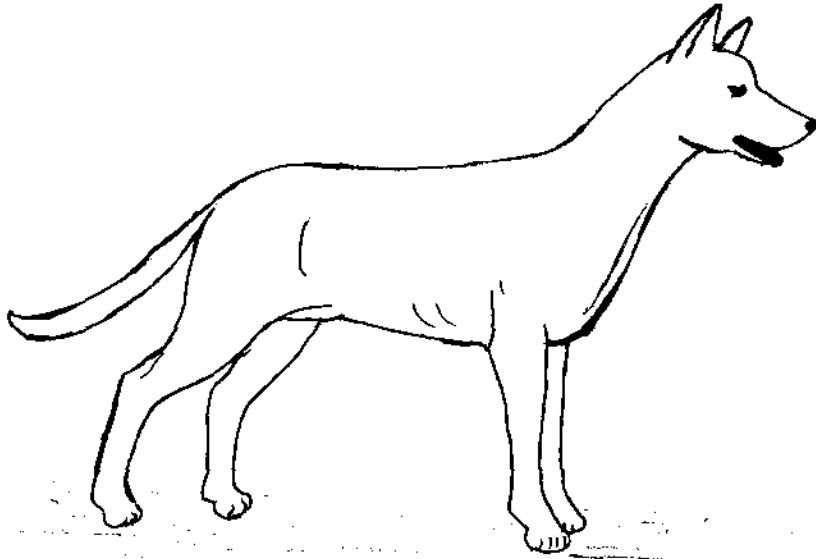

Ohuh

Nih ohuh.
Ohuh boluyan Bantáy.
Bantay banenteyan gunu.
Nabakan tauh kala diloan duh.

Ang Aso.
Itó ay aso.
Ang asong itó ay si Bantáy.
Si Bantáy ay nagbábantáy
ng bahay.
Tinátahulán niyá ang mga
taong dí niyá kilalá.

The Dog
This is a dog.
This dog is Bantay.
Bantay guards the house.
He barks at persons he
does not know.

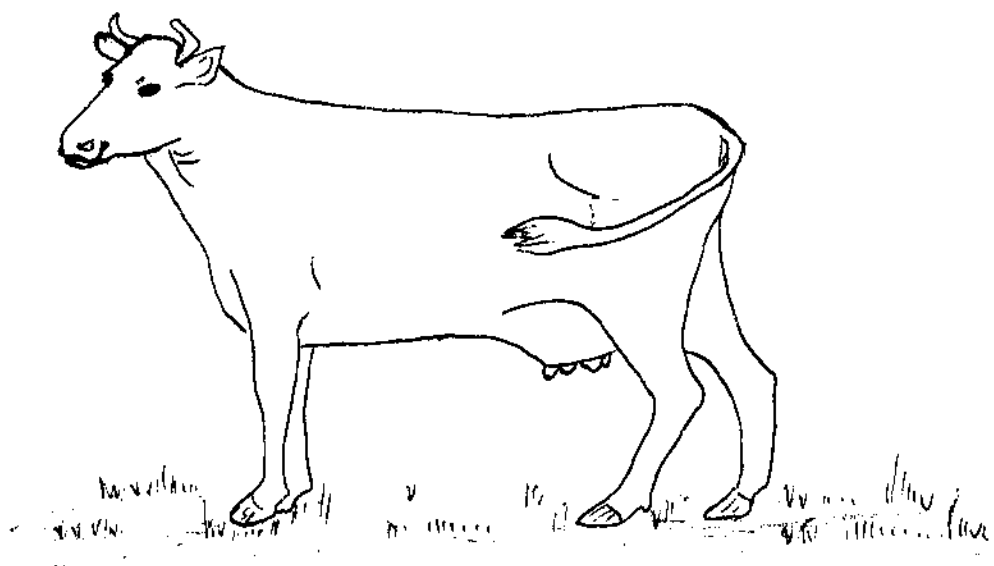

Safi

Nih safi
Kan takuy safi nah gatasan.
Tay hayuh kan safi nah gatasan.

Ang Baka
Itó ay baka.
Ang baka ay nagbíbigáy ng
karné at gatas.
Ang karné at gatas ng baka
ay masaráp.

The Cow
This is a cow.
The cow gives meat and
milk.
The meat and milk of the
cow are good.

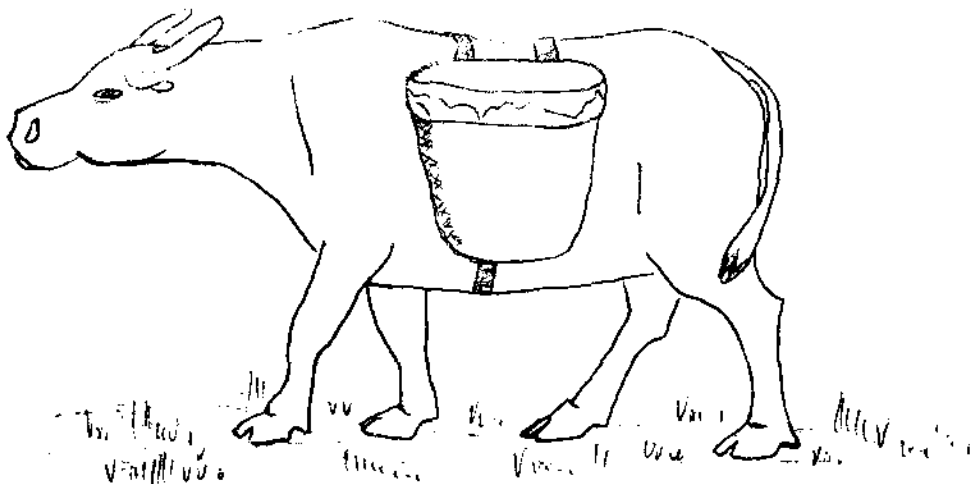

KALAMBAW

Nih kalambaw.

Yoh muhan kalambaw gal lumulon
blat nuwit.

Kan takuy kalambaw nah gatasan.

Ang Kalabaw

Itó ay kalabaw.

Ang kalabaw ay ginagamit sa
pagdadala ng mabigat.

Ang kalabaw ay nagbibigay
ng karné at gatas.

The Carabao

This is a carabao.

The carabao is used in
carrying heavy things.

The carabao gives meat
and milk.

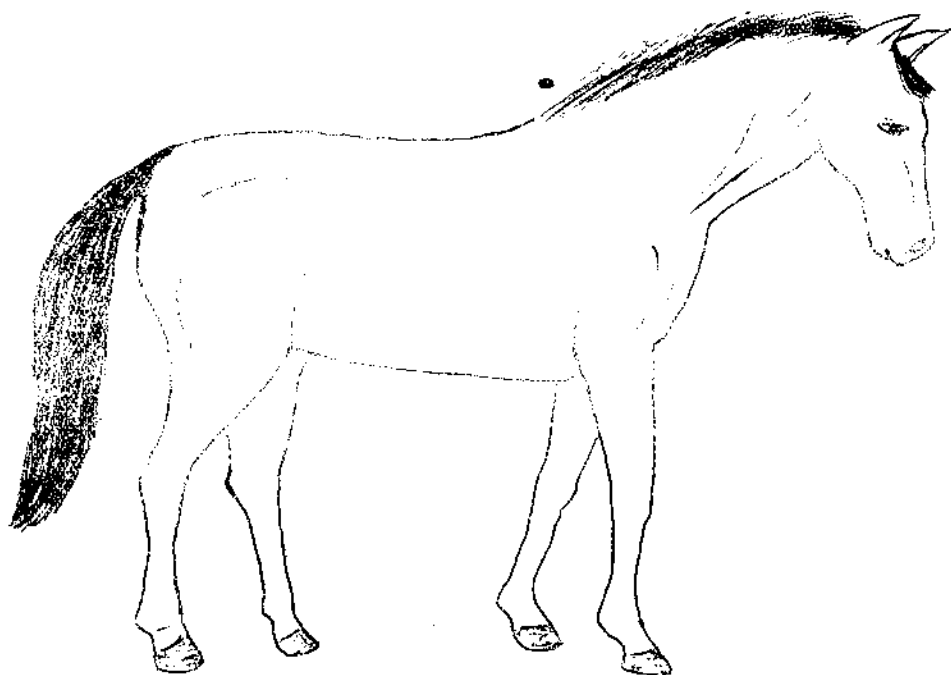

^u
Kōda

^u
Nih kōda.

Yeh muhan ^ukōda gal sanakay.

Yeh muhan kōda gal sankuyah lah.

Ang Kabayo

Itó ay kabayo.

Ang kabayo ay sinásakyán.

Ang kabayo ay ginagamit
sa karera.

The Horse

This is a horse.

The horse is used for riding.

The horse is used
in racing.

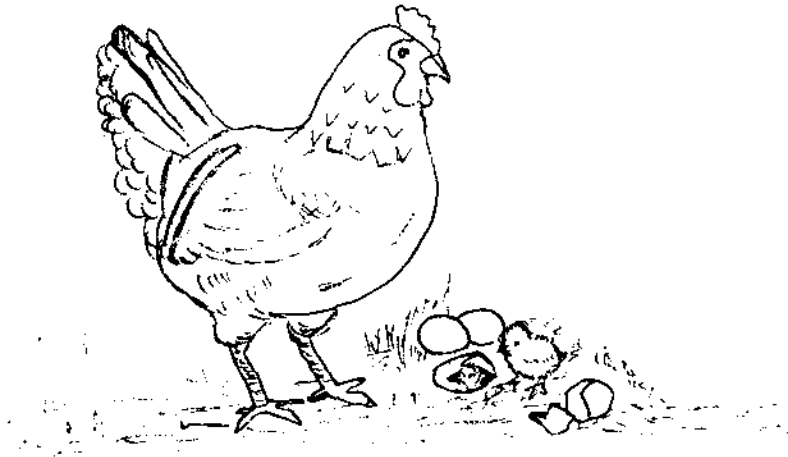

Malon

Nih malon.
Malon gal manga.
Nga onuk nisok malon.
Tay hayuh kan onuk.

Ang Inahing Manók
Itó ay inahin.
Ang inahin ay nagbibigáy
ng itlóg.
Ang itlóg ay pinípisá
ng inahin.
Ang karné ng inahin
ay masaráp.

The Hen
This is a hen.
The hen lays eggs.
The hen hatches
the eggs.
The meat of the hen
is good.

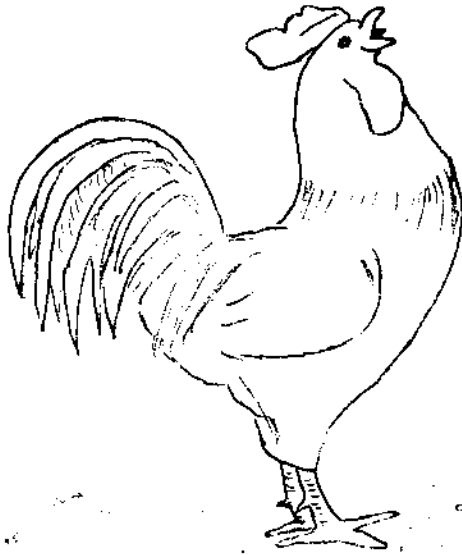

Mosol

Nih mosol.

Mosol batik tam kifuh.

Kamoot mosol.

Ang Tandáng

Itó ay tandáng.

Ang tandáng ay maagang
gumising.

Ang tandáng ay tumítlaok.

The Rooster

This is a rooster.

The rooster wakes up
early.

The rooster crows.

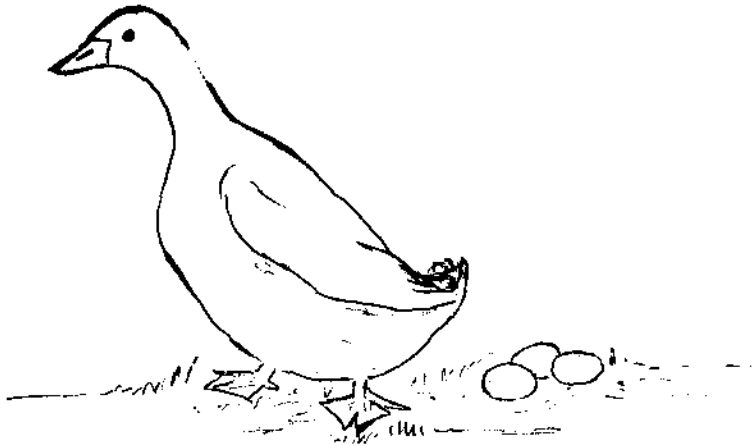

Inti

Nih inti.
Inti tay hayuh ugaf.
Inti gal manga.

Ang Pato
Itó ay pato.
Ang pato ay mabuting
alagà.
Ang pato ay nagbíbigáy ng itlóg.

The Duck
This is a duck.
The duck is a
good pet.
The duck lays eggs.

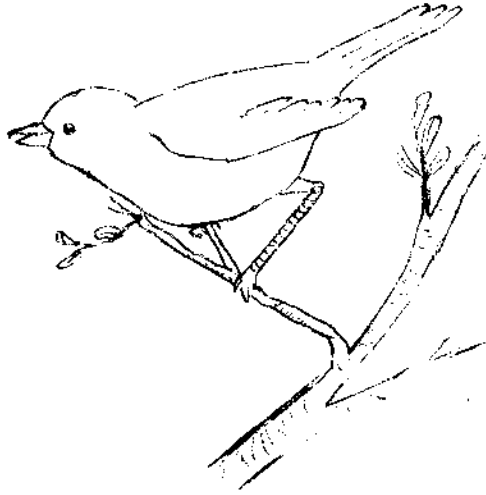

Onuk Koyuh

Nih onuk koyuh.
Onuk koyuh kanan kulad.
Kulad hansidakan kam huluh.
Onuk kanigalan takuy ba lingunan.

Ang Ibon
Itó ay ibon.
Ang ibon ay kumákain ng uod.
Ang uod ay sumísira
ng halaman.
Tayo ay inaálíw ng ibon
sa kanyáng awít.

The Bird
This is a bird.
The bird eats worms.
The worm destroys
plants.
The bird makes us glad
with his song.

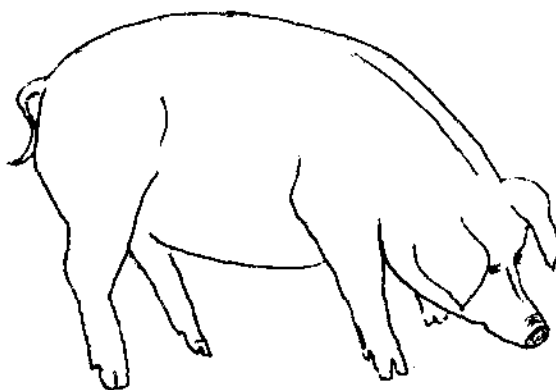

Sado

Nih sado.
Sado tay mahil mabu.
Kan takuy sado.
Abu sado gal hanbaling lah tobo.

Ang Baboy
Itó ay baboy.
Ang baboy ay madalíng
tumabá.
Ang karné ng baboy ay
kinákain.
Ang tabá ng baboy ay
ginágawáng mantiká.

The Pig
This is a pig.
The pig becomes fat
easily.
The meat of the pig
is eaten.
The fat of the pig is
made into lard.